

Article number: 03487040

Description: Fluro Rod end EAL 40D-2RS

Note: 40

Measures

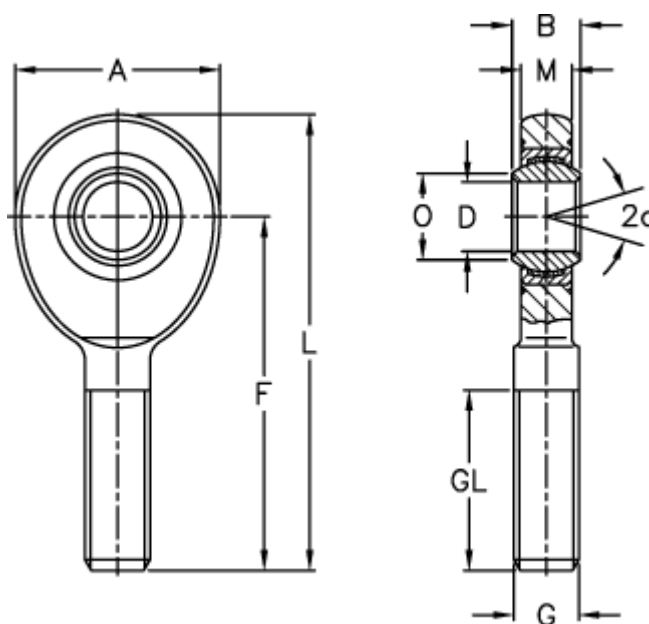

A	= 92	L	= 196
a (degrees)	= 7	M	= 23
B	= 28	O	= 45
D	= 40	Static drive kN	= 178
Dynamic drive (kN)	= 185	Weight	= 1800
F	= 150		
g	= M 39x3		
GL	= 86		